

SAFETY AND OPERATING MANUAL FOR 14" & 18" DUAL MOTOR UPRIGHT VACUUMS

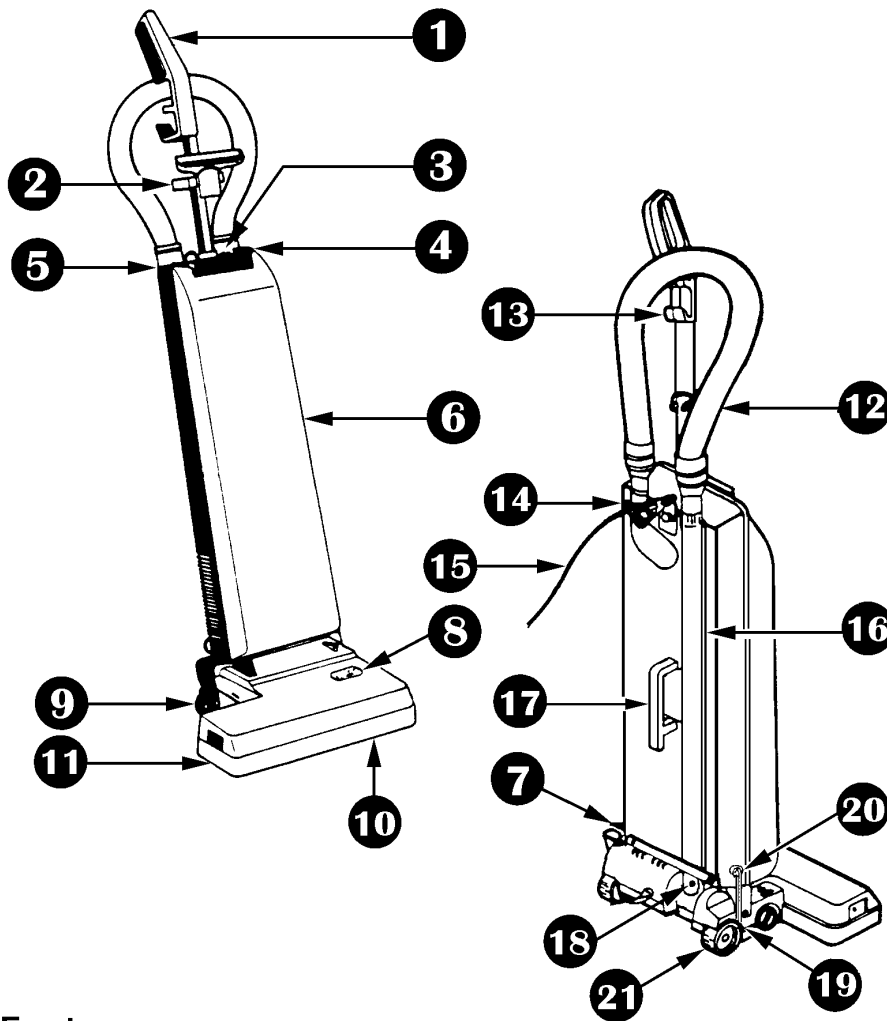

Features:

- | | |
|-------------------------|---------------------------------------|
| 1. Handle | 12. Hose |
| 2. Accessory Mount | 13. Upper Cord Hook |
| 3. Full Bag Light | 14. Secondary Cord Strain Relief |
| 4. Main Power Switch | 15. Power Cord |
| 5. Door Latch | 16. Wand |
| 6. Bag Housing | 17. Carrying Handle w/Lower Cord Hook |
| 7. Handle Release Lever | 18. Thumb Screw |
| 8. Electronic Display | 19. Base Inlet Connector |
| 9. Handle Pivot | 20. Cord Pigtail |
| 10. Power Brush Nozzle | 21. Rear Wheel |
| 11. Bumper | |

SAVE THESE INSTRUCTIONS

READ ALL INSTRUCTIONS BEFORE OPERATING

This vacuum cleaner will afford you many years of trouble-free operating satisfaction, provided it is given proper care. All parts have passed rigid quality control standards prior to being assembled to produce the finished product. Prior to packaging, this vacuum was again inspected for assurance of flawless assembly.

Your vacuum is protectively packed to prevent damage in shipment. We recommend that upon delivery, unpack the vacuum and inspect it for any possible damage. Only a visual examination will reveal damage that may have occurred.

If damage is discovered, immediately notify the transportation company that delivered your vacuum. As a shipper, we are unable to report claims for concealed damage. You must originate any claims within 5 days.

This manual is for your protection and information. **PLEASE READ CAREFULLY** since failure to follow precautions could result in discomfort or injury.

IMPORTANT SAFETY INSTRUCTIONS



WARNING:

Electric shock could occur if used on wet surfaces.
DO NOT expose to rain - Store Indoors
When using this electric vacuum, basic precautions should always be followed, including the following:

- 1) **DO NOT** leave the vacuum when plugged in. Unplug it from the outlet when not in use and before servicing.
- 2) This is **NOT** a toy. Close attention is necessary when used around or near children.
- 3) Use this vacuum only as described in this safety manual. Use only manufacturer's recommended attachments and accessories.
- 4) **DO NOT** use the vacuum with damaged cord or plug. If the vacuum is not working as it should, because it has been dropped, damaged, left outdoors or dropped into water, contact an authorized service center or factory.
- 5) **DO NOT** pull vacuum by the cord, use cord as a handle, close a door on the cord or pull cord around sharp edges and corners. **DO NOT** run vacuum over the cord. Keep cord away from heated surfaces.
- 6) **DO NOT** unplug the vacuum by pulling on the cord. To unplug, grasp the plug, not the cord.
- 7) **DO NOT** handle the vacuum plug or vacuum with wet hands.
- 8) **DO NOT** put any objects into openings. **DO NOT** use with any openings blocked; keep free of dust, lint, hair, and anything that may reduce air flow.
- 9) Turn **OFF** all of the controls before unplugging.
- 10) Keep hair, loose clothing, fingers, and all parts of the body away from openings and moving parts.
- 11) **DO NOT** pick up anything that is smoking or burning such as cigarettes, matches, or hot ashes.
- 12) **DO NOT** use without dust bag and/or filters in place.
- 13) Use extra care when cleaning on stairs.
- 14) **DO NOT** use this vacuum to pick up flammable or combustible liquids such as gasoline or use in areas where they may be present.
- 15) **DO NOT** use where anesthetics or oxygen is used.
- 16) Replace damaged or worn parts immediately with genuine original equipment parts to maintain safety and to protect your limited warranty.
- 17) **DO NOT** use an extension cord unless absolutely necessary. If an extension cord is used, then wire size must be #14 gauge or larger and should not exceed 50 feet in length. The extension cord must be three-wire type to insure **GROUNDING** protection.

This vacuum must be connected to a properly grounded outlet only. See grounding instructions (Page 3).

SAVE THESE INSTRUCTIONS



DANGER:

Improper use of the grounding plug can result in a risk of electric shock.

GROUNDING INSTRUCTIONS

Electrical equipment must be grounded. If it should malfunction or breakdown, grounding provides a path of least resistance for electrical current to reduce the risk of electric shock. This vacuum is equipped with a cord having an equipment-grounding conductor and grounding plug. The plug must be inserted into an appropriate outlet that is properly installed and grounded in accordance with all local codes and ordinances.

If repair or replacement of the cord or plug is necessary, **DO NOT** connect the grounded wire to either flat blade terminal. The wire with insulation having an outer surface that is green with or without yellow stripes is the grounding wire.

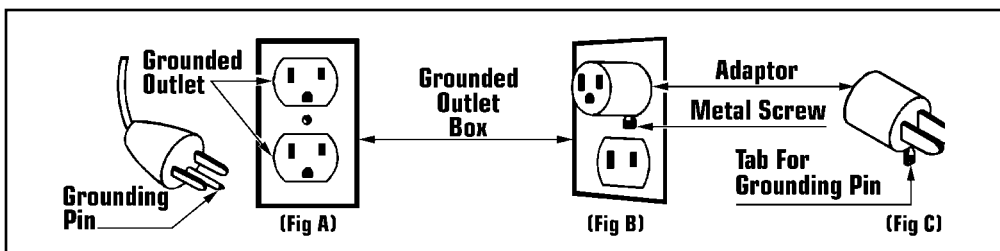

This electric equipment is for use on a nominal 120 volt circuit, and has a grounded plug that looks like the plug illustrated in (Fig A). A temporary adaptor that looks like the adaptor illustrated in (Fig B & C) may be used to connect this plug to a 2-pole receptacle as shown in (Fig B) if a properly grounded outlet is not available.

The temporary adaptor should be used only until a properly grounded outlet (Fig A) can be installed by a qualified electrician. The green color rigid ear, lug or the like extending from the adaptor must be connected to a permanent ground such as a properly grounded outlet box cover. Whenever the adaptor is used, it must be held in place by a metal screw. (See Fig B)

GROUNDING METHODS



WARNING:

Improper connection of the equipment-grounding conductor can result in a risk of electric shock. Check with a qualified electrician or service person if you are in doubt as to whether the outlet is properly grounded.

DO NOT modify the plug provided with the equipment. If it will not fit the outlet, have a proper outlet installed by a qualified electrician.

Note: In Canada, the use of a temporary adaptor is not permitted by the Canadian Electrical Code.

IMPORTANTES MESURES DE SECURITE

1) Ne pas laisser l'appareil sans surveillance lorsqu'il est branché. Débrancher lorsque l'appareil n'est pas utilisé et avant l'entretien.

2) Ne pas permettre aux enfants de jouer avec l'appareil. Une attention particulière est nécessaire lorsque l'appareil est utilisé par des enfants ou à proximité de ces derniers.

3) N'utiliser que conformément à cette notice avec les accessoires recommandés par le fabricant.

4) Ne pas utiliser si le cordon ou la fiche est endommagé. Retourner l'appareil à un atelier de réparation s'il ne fonctionne pas bien, s'il est tombé ou s'il a été endommagé, oublié à l'extérieur ou immergé.

5) Ne pas débrancher en tirant sur le cordon. Tirer plutôt la fiche.

LIRE TOUTES LES INSTRUCTIONS AVANT DE FAIRE FONCTIONNER (CET APPAREIL)

AVERTISSEMENT:

Pour réduire les risques d'incendie, de choc électrique ou de blessure:

6) Ne pas tirer, soulever ou traîner l'appareil par le cordon. Ne pas utiliser le cordon comme une poignée, le coincer dans l'embrasure d'une porte ou l'appuyer contre des arêtes vives ou des coins. Ne pas faire rouler l'appareil sur le cordon. Garder le cordon à l'écart des surfaces chaudes.

7) N'insérer aucun objet dans les ouvertures. Ne pas utiliser l'appareil lorsqu'une ouverture est bloquée. S'assurer que de la poussière, de la peluche, des cheveux ou d'autres matières ne réduisent pas le débit d'air.

8) Ne pas toucher la fiche ou l'appareil lorsque vos mains sont humides.

9) Maintenir les cheveux, les vêtements amples, les doigts et toutes les parties du corps à l'écart des ouvertures et des pièces mobiles.

10) Ne pas utiliser l'appareil si le sac à poussière ou le filtre n'est pas en place.

11) Ne pas aspirer de matières en combustion ou qui dégagent de la fumée, comme des cigarettes, des allumettes ou des cendres chaudes.

12) Mettre toutes les commandes à la position ARRET avant de débrancher l'appareil.

13) User de prudence lors du nettoyage des escaliers.

14) Ne pas aspirer des liquides inflammables ou combustibles, comme de l'essence, et ne pas faire fonctionner dans des endroits où peuvent se trouver de tels liquides.

15) Toujours mettre l'interrupteur de l'appareil à la position ARRET avant de brancher ou de débrancher la brosse à moteur.

16) Ne brancher qu'à une prise de courant avec mise à la terre. Voir les instructions visant la mise à la terre.

INSTRUCTIONS VISANT LA MISE A LA TERRE

Cet appareil doit être mis à la terre. En cas de défaillance ou de panne éventuelles, la mise à la terre fournit au courant un chemin de moindre résistance qui réduit le risque de choc électrique. Cet appareil est pourvu d'un cor-

don muni d'un conducteur de terre et d'une fiche avec broche de terre. La fiche doit être branchée dans une prise appropriée correctement installée et mise à la terre conformément aux règlements et ordonnances municipaux.

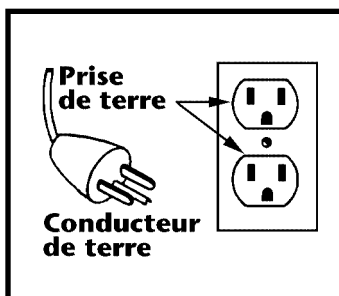

Cet appareil est destiné à un circuit de 120V et est muni d'une fiche de mise à la terre semblable à celle illustrée par le croquis A de la figure "A". S'assurer que l'appareil est branché à une prise de courant ayant la même configuration que la fiche. Aucun adaptateur ne devrait être utilisé avec cet appareil.

AVERTISSEMENT

Un conducteur de terre mal raccordé peut entraîner un risque de choc électrique. Consulter un électricien ou un technicien d'entretien qualifié si vous n'êtes pas certain que la prise soit cor-

rectement mise à la terre. Ne pas modifier la fiche fournie avec l'appareil-si elle ne peut être insérée dans la prise, faire installer une prise adéquate par un électricien qualifié.

HANDLE ASSEMBLY & ATTACHMENT INSTALLATION

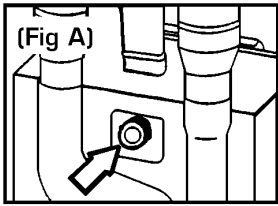

Carefully unpack the vacuum, checking carefully to ensure that you have located all necessary components.

1. Handle Assembly: Slide handle into the opening of the vacuum housing until it bottoms out (Fig A). Secure handle with the thumb screw that is packed with operation instructions.

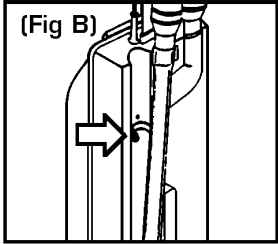

2. Hose Installation: Push one end of the hose into the top opening of the vacuum housing. Push the other end of the hose into the wand. If the operator prefers, the hose may be slid into the notch in back of the handle.

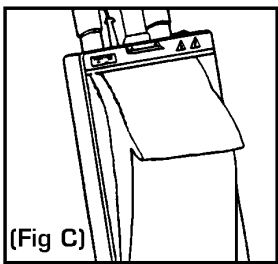

3. Wand Installation: Push lower end of wand into the fitting on the power nozzle and snap wand into the depression in back of the vacuum housing. (See Fig B)

4. Filter Bag Installation: Open the vacuum housing door by pushing down on the latch and swinging door down. Push filter bag onto the bag mount as far as it will go. Fold the top of the bag down so it won't interfere with the door latch. (Fig C)

5. Tool Installation: Snap the upholstery and crevice tool into the holder on the handle.

6. Cord Storage: Coil the cord and hanging it on the upper hook, or wrap it around upper and lower hook.



Secondary Strain Relief

Handle Screw

This vacuum come with a secondary strain relief to protect the power cord from damage. It is important that you follow the installation instruction below.

SECONDARY STRAIN RELIEF INSTALLATION INSTRUCTIONS



Step 1
Place strain relief bracket on post behind the handle.



Step 2
Tighten the thumb screw to hold the bracket in place.



Step 3
Slide the cord loop thru the bottom hole of the triangle.



Step 4
Take the loop and hook it over the center clip.



Step 5
The secondary strain relief is now in place.

OPERATION INSTRUCTIONS

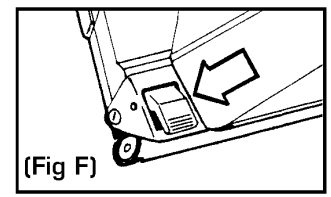
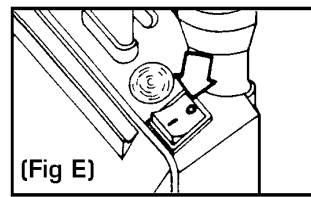
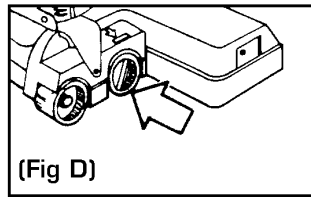

1. Plug the power cord into a 115 volt, 60 cycle receptacle.

2. Adjust the brush height knob to suit the carpet thickness you are working on. (See Fig D)

NOTE: On the 18" upright, you may need to set the height adjustment at (3) for low pile carpet during the (3 Months) break-in period.

3. Turn the main power rocker switch to "ON". The vacuum motor will start (Fig E).

4. Depress the **YELLOW** foot pedal and lower the handle to the operating position. When the handle is lowered, the brush motor will start. Use normal vacuuming procedures. (Fig F)

SAFE-GUARD FEATURES

Full Bag Indicator

Your vacuum has an indicator light which will flash **RED** if the bag is full or airflow is obstructed. When the indicator light is on, open the door and check the bag.

If the bag is full, replace it. If is not full and the light is **ON**, there is an obstruction in the system. Check the hose and wand first. If they are clear, check the inlet in the power brush base by removing wand from the inlet and viewing the air path from the inlet to the brush. If this area is clear, remove the bag and check deflector port in the top of vacuum housing.

Thermal Overload On Vacuum Motor

This vacuum is equipped with a sensor that shuts off the vacuum motor if the internal temperature is too high. This is normally created by an obstruction in the system cutting off the air flow.

If the motor stops during use:

- A. Turn **OFF** main switch.
- B. Unplug vacuum from receptacle.
- C. Inspect and remove obstruction.

The motor will automatically restart when the switch **ON** and when has motor cooled sufficiently.

Electronic Power Alert

This vacuum has an electronic control that alerts the operator to problems in the brush section.

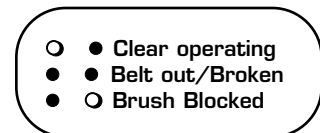

Green Light

Lower section operating properly.

Red Light

Brush roll obstructed.

Red & Green Lights ON

Drive belt broken.

The operator must constantly monitor the alert lights for proper performance and correct problems immediately.

Before Each Use

Check to ensure that the filter bag is in place and that it is not full. Replace if necessary. Inspect the brush area and remove any threads, strings, or debris that may be wrapped around the brush.

CAUTION: Belt replacement or other repairs to the lower section should only be performed by an authorized service center.



CAUTION:

Always turn **OFF** the main switch and unplug the cord before performing any maintenance

OPERATION INSTRUCTIONS FOR ABOVE FLOOR CLEANING

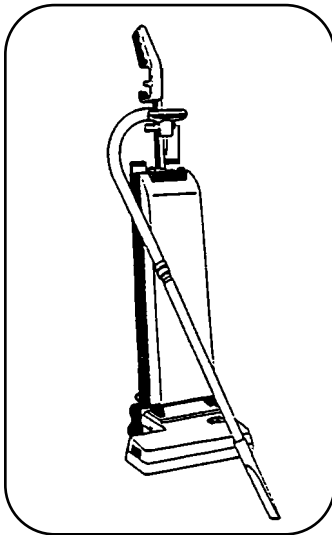

Step One

Remove wand by snapping it out of the retainer clip and pulling from the inlet in the base. The brush motor will automatically stop when the wand is removed.

Step Two

Attach the tool of your choice to the wand and start cleaning.

NOTE: When replacing the wand, make sure that it fits tightly into base inlet for proper performance.

Weekly Maintenance

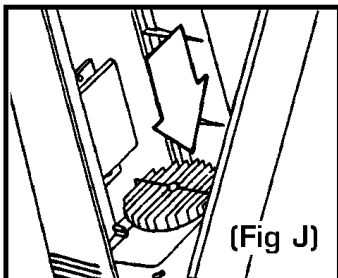

Inspect the vacuum motor inlet filter. Snap filter retainer out of its fitting. Remove the filter and clean it by vacuuming or shaking.

Replace with new filter if uncleanable or torn. Replace filter in retainer and snap in place in the vacuum housing.

CAUTION:

DO NOT operate vacuum without motor inlet filter in place. (See Fig J)

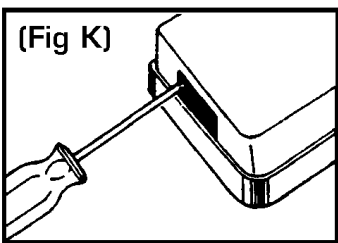

Monthly Maintenance

Inspect brush strip for wear. If worn to the point where it no longer touches the carpet, it must be replaced.

To Replace Brush Strips:

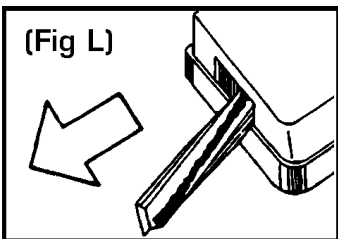

Remove the phillips head screw holding the brush access plate in place on the end of the brush extension. Slide the strip out and replace with a new one. Make sure brush strip is pushed all the way in. Replace the access door. (See Figs K & L)

Annual Maintenance

Motor brushes in the vacuum and brush motor must be inspected for wear.



CAUTION:

Brushes should be replaced only by authorized maintenance personnel.

MAINTENANCE OF THE VACUUM

TROUBLE SHOOTING GUIDE

PROBLEM: Vacuum motor does not run.

POSSIBLE CAUSE:

1. Power cord may not be plugged in.
2. Break in power cord.
3. Thermal overload tripped due to obstruction or full bag.
4. Main switch failure.
5. Carbon motor brushes worn.
6. Motor failure.

POSSIBLE SOLUTION:

1. Check to make sure power cord is plugged into vacuum and outlet.
2. Repair or replace cord.
3. Remove obstruction or change bag.
4. Replace switch.
5. Replace brushes.
6. Replace motor.

PROBLEM: Brush motor does not run.

POSSIBLE CAUSE:

1. Lower cable not plugged into receptacle in vacuum housing.
2. Handle not in operating position.
3. Wand not seated in holder properly.
4. Brush obstructed. (Red Light **ON**)
5. Belt broken. (Red & Green Lights **ON**)
6. Carbon motor brushes worn.
7. Motor failure.

POSSIBLE SOLUTION:

1. Plug into receptacle.
2. Lower handle.
3. Snap wand properly into holder.
4. Remove obstruction.
5. Replace belt.
6. Replace carbon brushes.
7. Replace motor.

PROBLEM: Low suction power.

POSSIBLE CAUSE:

1. Filter bag full.
2. Vacuum inlet filter plugged.
3. Hose plugged with debris.
4. Hose/wand not connected properly.

POSSIBLE SOLUTION:

1. Replace filter bag.
2. Clean or replace.
3. Remove debris from hose.
4. Check installation.

PROBLEM: Poor pickup on carpet.

POSSIBLE CAUSE:

1. Low suction power.
2. Brush area obstructed.
3. Brush strip worn.
4. Brush not adjusted properly for carpet pile height.

POSSIBLE SOLUTION:

1. Check solutions above.
2. Remove obstruction.
3. Replace brush strip.
4. Check/change adjustment.

CAUTION:

Disconnect power cord from outlet before servicing this vacuum.



777 South Street, Newburgh NY 12550-0606
TEL: 800.835.7812 ♦ 845.565.8850
FAX: 800.752.6883 ♦ 845.565.9392
www.mastercraftusa.com ♦ sales@mastercraftusa.com