

# The 14" Upright Commercial Vacuum Cleaner Aspiradora/Aspirateur

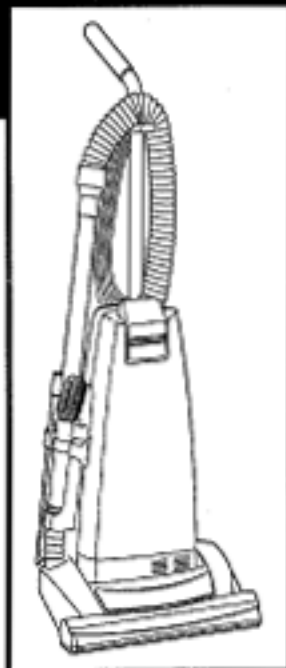

## Operating Instructions Instrucciones de operación Manual d'utilisation

Before operating this vacuum cleaner, please read these instructions completely.

*Antes de usar su aspiradora, lea completamente estas instrucciones por favor.*

**Avant d'appareil, il est recommandé de lire attentivement ce manuel.**

This vacuum cleaner will afford you many years of trouble-free operating satisfaction, provided it is given proper care. All parts have passed rigid quality control standards prior to being assembled to produce the finished product. Prior to packaging, the vacuum cleaner was again inspected for assurance of flawless assembly.

Your vacuum cleaner is protectively packed to prevent damage in shipment. We recommend that upon delivery, unpack the vacuum cleaner and inspect it for any possible damage.

Only a visual examination will reveal damage that may have occurred.

If damage is discovered, immediately notify the transportation company that delivered your vacuum cleaner. As a shipper, we are unable to report claims for concealed damage. You must originate any claims within 5 days.

### **PLEASE READ CAREFULLY**

This manual is for your protection and information. Failure to follow the precautions in the manual could result in discomfort or injury.

**Mastercraft**

**QC-1415**

777 South Street,  
Newburgh NY 12550  
TEL: 845.565.8850  
FAX: 845.565.9392

URL: [www.mastercraftusa.com](http://www.mastercraftusa.com)

## Customer Information

Please read **IMPORTANT SAFETY INSTRUCTIONS** on page 4 before use. Read and understand all instructions.

### TO OUR VALUED CUSTOMER

Thank you for purchasing this product. Our intent is that you become one of our many satisfied customers.

Proper assembly and safe use of your vacuum cleaner is your responsibility. Your vacuum cleaner is intended for commercial use. The vacuum cleaner should be stored in a dry, indoor area. Read the Operating Instructions carefully for important use and safety information.

Special care is required when vacuuming certain types of carpet or floor covering. Always check the carpet or floor covering manufacturer's recommended cleaning instructions before vacuuming.

### PLEASE PAY CLOSE ATTENTION TO ALL WARNING AND CAUTION STATEMENTS.



**WARNING** statements are designed to alert you to the possibility of personal injury, loss of human life, and/or damage to the vacuum cleaner and/or personal property if the instructions given are not followed.



**CAUTION** statements are designed to alert you to the possibility of damage to the vacuum cleaner and/or personal property if the instructions given are not followed.

### **WARNING**

#### **TO AVOID ELECTRICAL SHOCK**

Never vacuum damp or wet surfaces or liquids.  
DO NOT store vacuum cleaner outdoors.  
Replace worn or frayed power cord immediately.  
Unplug from outlet when not in use and before servicing.

#### **TO AVOID ACCIDENTS**

Except for hand-held cleaners, keep vacuum cleaner on floor - not chairs, tables, steps, stairs, etc.  
Store vacuum cleaner promptly after each use to prevent accidents such as tripping over power cord or vacuum cleaner.  
Use vacuum cleaner and accessories only in a manner intended by the manufacturer.  
The use of an extension cord is not recommended.

# Table of Contents

<b>Assembly of Vacuum Cleaner</b> .....	.8
<b>Belt Replacement</b> .....	.13
<b>Brush Replacement</b> .....	.12
<b>Cleaning Clogged Hose</b> .....	.14
<b>Customer Information</b> .....	.2
<b>Features of Vacuum Cleaner</b>	
Automatic Self Adjusting Nozzle .....	.7
Edge Cleaning .....	.7
Tools - Use and Cleaning .....	.6
Vacuum Cleaner Features .....	.6
<b>Filter Bag Changing</b> .....	.10
<b>Grounding Instructions</b> .....	.5
<b>Important Safety Instructions</b> .....	.4
<b>Operating Instructions</b> .....	.9
<b>Routine Maintenance</b>	
Agitator Cleaning .....	.11
Cleaning Vacuum Cleaner Exterior .....	.14
Replacing Secondary Hepa Filter .....	.11
Removing & Installing Lower Plate .....	.11
<b>Trouble Shooting Guide</b> .....	.15
<b>Warranty</b> .....	.16
<b>Manual in Spanish Section</b> .....	.1A
<b>Manual in French Section</b> .....	.1B

# IMPORTANT SAFETY INSTRUCTIONS

When using this vacuum cleaner, basic precautions should always be followed, including the following:

## READ ALL INSTRUCTIONS BEFORE USING THIS VACUUM CLEANER

### WARNING

To Reduce the risk of fire, electric shock, injury:

1. **Read** all instructions in this manual before assembling or using your vacuum cleaner.
2. **Use** your vacuum cleaner only as described in this manual. Use only manufacturer's recommended attachments and accessories.
3. **Disconnect** electrical supply before servicing or cleaning out the brush area. Failure to do so could result in electrical shock or the brush suddenly starting.
4. **Do not** leave vacuum cleaner when plugged in. Unplug from outlet when not in use and before servicing.
5. **To reduce the risk of electrical shock - Do not use outdoors or on wet surfaces.**
6. **Do not** allow to be used as a toy. Close attention is necessary when used by or near children.
7. **Do not** use with a damaged cord or plug. If vacuum cleaner is not working as it should, has been dropped, damaged, left outdoors, or dropped in water, return it to a Panasonic Service Center.
8. **Do not** pull or carry by cord, use cord as a handle, close a door on cord, or pull cord around sharp edges or corners. Do not run vacuum cleaner over cord. Keep cord away from heated surfaces.
9. **Do not** unplug by pulling on cord. To unplug, grasp the plug, not the cord.
10. **Do not** handle plug or vacuum cleaner with wet hands.
11. **Do not** put any objects into openings.
12. **Do not** use with any opening blocked; keep free of dust, lint, hair, and anything that may reduce air flow.
13. **Keep** hair, loose clothing, fingers, and all parts of body away from openings and moving parts.
14. **Turn off** all controls before unplugging.
15. **Use extra care** when cleaning on stairs. Do not put on chairs, tables, etc. Keep on floor.
16. **Do not** use vacuum cleaner to pick up flammable or combustible liquids (gasoline, cleaning fluid, perfumes, etc.), or use in areas where they may be present. The fumes from these substances can create a fire hazard or explosion.
17. **Do not** pick up anything that is burning or smoking, such as cigarettes, matches, or hot ashes.
18. **Do not** use vacuum cleaner without dust bag and/or filters in place.
19. **Connect** to a properly grounded outlet only. See Grounding Instructions.
20. **You** are responsible for making sure that your vacuum cleaner is not used by anyone unable to operate it properly.

## SAVE THESE INSTRUCTIONS

### THIS VACUUM CLEANER IS INTENDED FOR COMMERCIAL USE

**NOTE:** Before you plug in your vacuum cleaner, make sure that the voltage indicated on the rating plate located at the back of the vacuum cleaner is the same as your local electrical supply.

# Grounding Instructions

## DANGER:

Improper use of the grounding plug can result in a risk of electric shock.

Electrical equipment must be grounded. If it should malfunction or breakdown, grounding provides a path of least resistance for electrical current to reduce the risk of electric shock. This vacuum cleaner is equipped with a cord having an equipment-grounding conductor and grounding plug. The plug must be inserted into an appropriate outlet that is properly installed and grounded in accordance with all local codes and ordinances.

If repair or replacement of the cord or plug is necessary, **DO NOT** connect the grounded wire to either flat blade terminal. The wire with insulation having an outer surface that is green with or without yellow stripes is the grounding wire.

## Grounding Methods

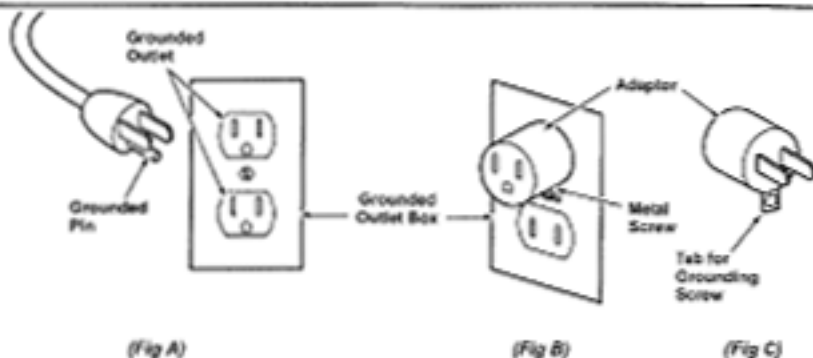

This electric equipment is for use on a nominal 120 volt circuit, and has a grounded plug that looks like the plug illustrated in (Fig A). A temporary adaptor that looks like the adaptor illustrated in (Fig B & C) may be used to connect this plug to a 2-pole receptacle as shown in (Fig B) if a properly grounded outlet is not available.

The temporary adaptor should be used only until a properly grounded outlet (Fig A) can be installed by a qualified electrician. The green color rigid ear, lug or the like extending from the adaptor must be connected to a permanent ground such as a properly grounded outlet box cover. Whenever the adaptor is used, it must be held in place by a metal screw. (See Fig B)

## WARNING:

Improper connection of the equipment-grounding conductor can result in a risk of electric shock. Check with a qualified electrician or service person if you are in doubt as to whether the outlet is properly grounded.

**DO NOT** modify the plug provided with the equipment. If it will not fit the outlet, have a proper outlet installed by a qualified electrician.

Note: In Canada, the use of a temporary adaptor is not permitted by the Canadian Electrical Code.

# Vacuum Cleaner w/Tools Features

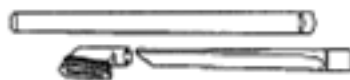
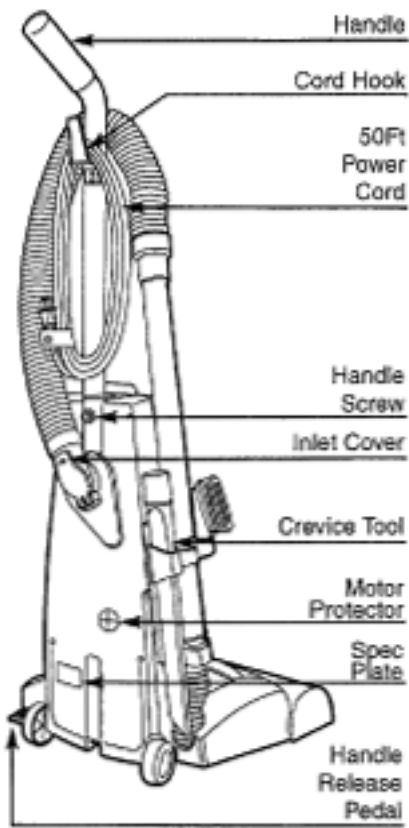
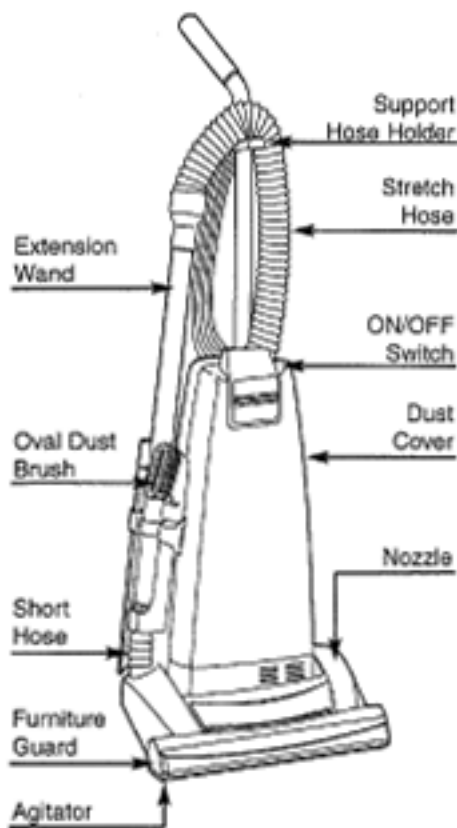

## TO USE TOOLS

- Place vacuum cleaner in upright position.
- Remove the wand from the short hose by twisting and pulling up.
- Attach hose to wand, and install the tool you need for cleaning. The tool can also be attached to the hose only.
- **DO NOT** overextend your reach with the hose as it could tip the vacuum cleaner.

- Place hose, wand and tools where stored on vacuum cleaner at end of cleaning operation.

## TO CLEAN TOOLS

- Unplug cord from wall outlet.
- Wash tools in warm soapy water, rinse and air dry.
- **DO NOT** use tools if they are wet.

# Vacuum Cleaner Features

## Edge Cleaning

- Edge cleaning feature provides for improved cleaning of carpets near walls and furniture.



## Automatic Self Adjusting Nozzle

- The nozzle of this upright vacuum cleaner automatically adjust to any carpet pile height.
- This feature allows the nozzle to float evenly over carpet surface.
- Manual adjustment is not required.

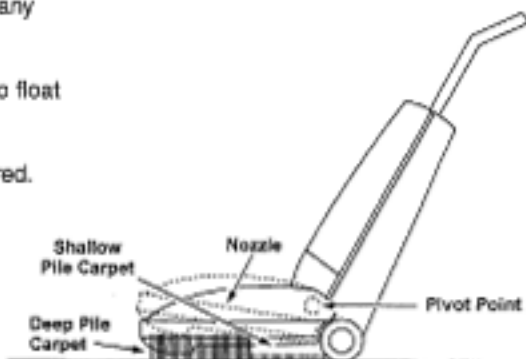

## Motor Protector

- Automatically opens to provide cooling air to the motor when a clog occurs or when the filter bag needs changing.
- The motor protector may open when using tools.
- If the motor protector opens, the vacuum cleaner will make a slightly different sound.
- **DO NOT BLOCK MOTOR PROTECTOR.**

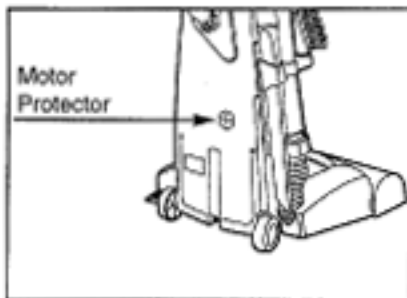

# Vacuum Cleaner Assembly

This upright vacuum cleaner requires some assembly. Carefully unpack the vacuum cleaner and attachments from the carton. The handle needs to be attached to the vacuum cleaner's body. The paper filter bag has already been installed on the inlet. As a precaution you should check to make sure the bag is still properly installed.

**DO NOT** plug the vacuum cleaner in until assembly is complete.

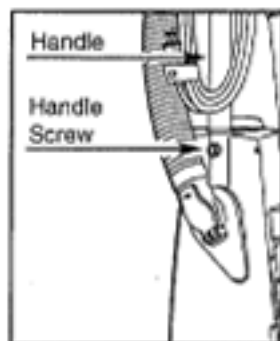

1)

- > Remove handle screw.
- > Insert handle into the opening on the back of vacuum cleaner.

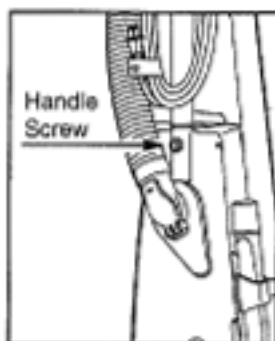

2)

- > Reinsert screw and tighten

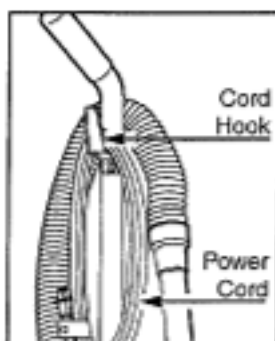

3)

- > Hang power cord over the cord hook.



# Operation Instructions

## ON-OFF Switch

- Ensure ON-OFF switch is OFF.
- Plug the power cord into 120V outlet.
- ON position turns vacuum cleaner on.
- OFF position turns vacuum cleaner off.

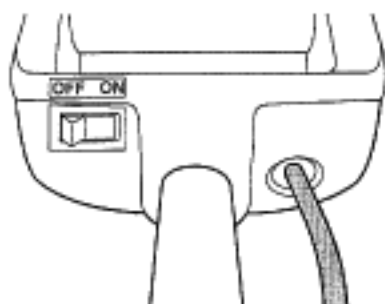

## Handle Adjustment

- 1)  
➤ Step on handle release pedal to change handle position.

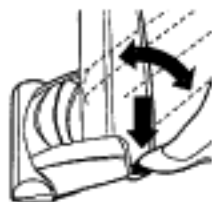

- 2)  
➤ Move the vacuum cleaner to upright position for storage and tool use.

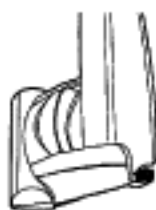

- 3)  
➤ Move vacuum cleaner to middle position for normal use.

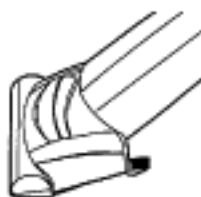

- 4)  
➤ Use low position for cleaning under furniture.



# Changing The Filter Bag

Always operate this vacuum cleaner with the paper filter bag or cloth filter bag installed. The filter bags may be purchased through an authorized distributor.

**1**

Pull outward on the dust cover grip to remove the dust cover.

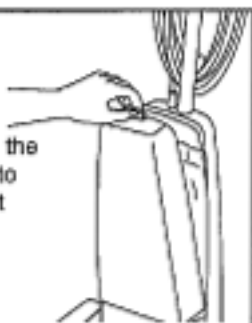

**2**

**To Remove Bag:**

Grasp the sides of the cardboard and pull it off the inlet.

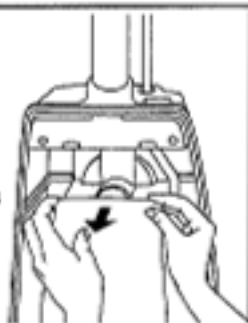

**3**

**Paper Bag Only:**

Open cardboard inlet tab (B) by pushing from the rear. Expand the bag pleats (A) carefully.

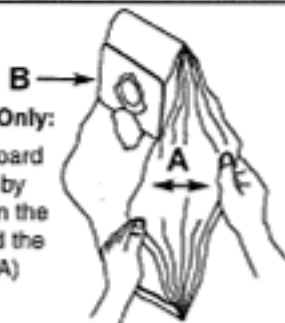

**4**

**To Install Bag:**

Hold onto the sides of cardboard (B) and push all the way onto the inlet (C).

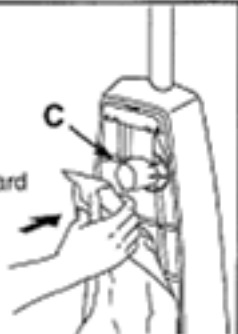

**5**

Tuck the filter bag bottom (D) all the way into the bottom of bag chamber.

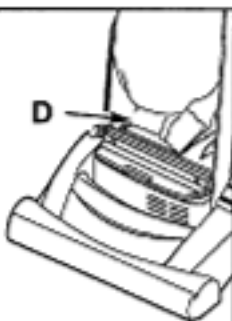

**6**

Install dust cover (E) into the groove (F) and push cover closed avoiding pinching the bag.



## Routine Maintenance

The following routine maintenance will keep this upright vacuum cleaner operating at peak performance levels and will ensure these high levels for years to come. Check Trouble Shooting Guide Section in the manual to help solve various problems that may occur.

### Replacing Secondary HEPA Filter

- Secondary HEPA filter protects the motor.
- Check filter when installing a new dust bag.
- If dirty, pull filter from bottom of dust compartment and replace.
- Place new filter, white side up, in dust compartment, **DO NOT CLEAN WITH WATER\***.
- Ensure filter is fully inserted under plastic rib projections.

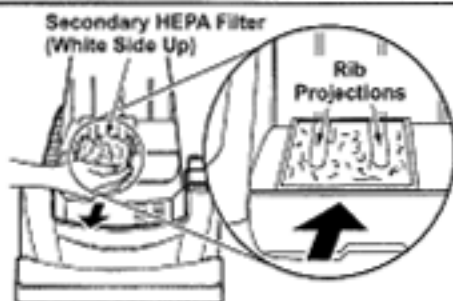

\*HEPA Filter (P/N 450154) cannot be cleaned and should be replaced at least once each year.

### Removing and Installing Lower Plate

- Before servicing any parts, disconnect vacuum cleaner from electrical outlet.
- Always place paper under nozzle anytime lower plate is removed to protect floor.
- Place handle in upright position and turn vacuum cleaner over to expose lower plate.
- Release lower plate by pressing two (2) latches and two (2) locking tabs inward as shown.
- Remove lower plate and remove any residue that may exist in belt area.
- Reinstall lower plate by hooking front end of lower plate into slots on front of nozzle housing.
- Press lower plate until locking tabs snap into place then push two (2) latches outward.

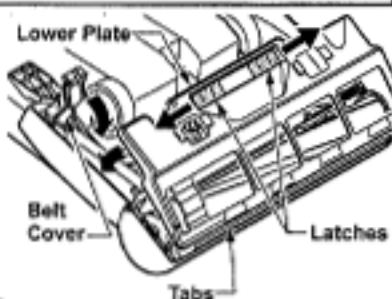

### Cleaning Agitator

- Clean agitator after every five uses and every time the belt is replaced.
- Remove lower plate.
- Cut off and remove any carpet pile and lint entangled around agitator with a pair of scissors.
- Remove agitator.
- Reinstall agitator and lower plate.

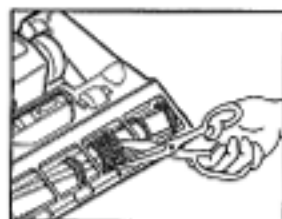

# Brush Replacement Instructions

- When the bristles on the agitator are worn so that they do not touch a card held across the lower plate, the brushes should be replaced.
- **Unplug the vacuum cleaner.**
- Remove lower plate and agitator.
- Remove the E-clip from agitator shaft and end cap.
- Do not bend agitator shaft or lose E-clip.
- Pull agitator shaft out of agitator body.
- Pull, or pry out, agitator holder and belt pulley.
- Push each brush out of agitator body as shown.
- Install new brushes by reversing procedure.
- Reinstall agitator holder and agitator pulley completely.
- Reinstall the agitator shaft, end cap and E-clip.
- See exploded view below for correct assembly of parts.
- Position belt over belt pulley on the agitator.
- Reinstall agitator and lower plate.

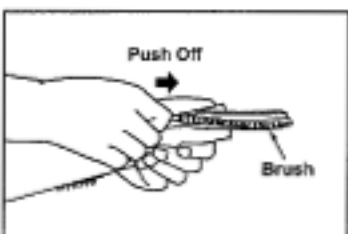
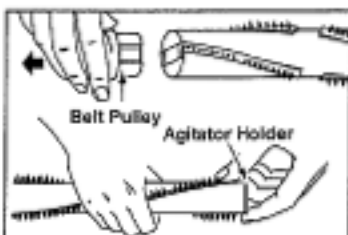
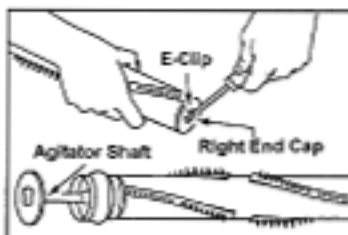
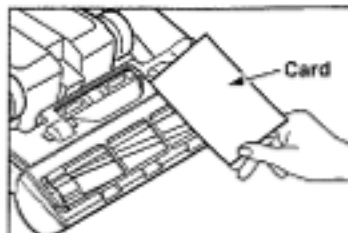

## Agitator Assembly

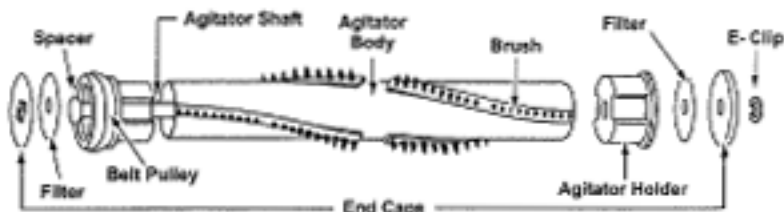

## Replacing Belt

- Replace belt whenever a burning rubber smell occurs caused by excessive slippage.
- **Unplug the vacuum cleaner.**
- Remove lower plate.
- Remove agitator by carefully lifting out.
- Remove worn or broken belt.
- Loop new belt (P/N 450170) around motor shaft and brush pulley; see illustration for correct belt routing.
- Clean agitator, and motor shaft.
- Reinstall agitator back into nozzle housing grooves.
- After reinstalling the agitator, turn it by hand to make sure that belt is not twisted or pinched and that all rotating parts turn freely.
- Reinstall lower plate.

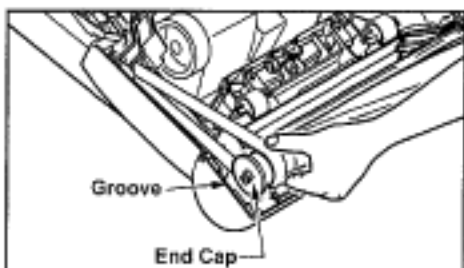
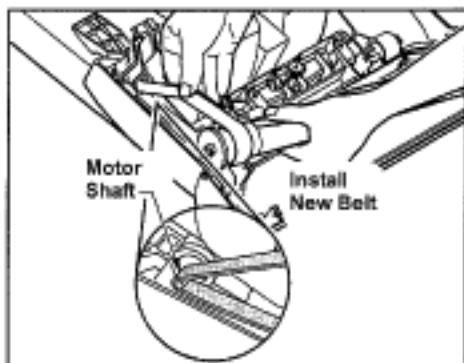
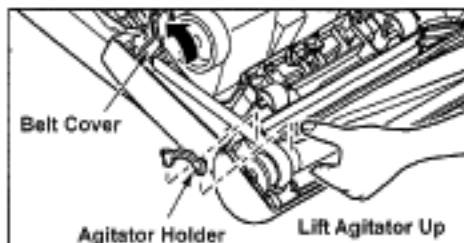

## Cleaning Clogged Hose

The hose located on the back of the vacuum cleaner carries the dirt from the nozzle up to the filter bag.

### If the hose should become clogged:

- Unplug cord from the wall outlet.
- Pull open the vacuum cleaner inlet cover and check for clogging.
- Disconnect wand from short hose and check wand and hose.
- Plug in vacuum cleaner and turn **ON**.
- Disconnect wand and stretch hose in and out to remove the clog.
- If clog still exists, turn vacuum cleaner **OFF** and **UNPLUG POWER CORD**.
- Remove lower plate.
- Remove short hose from nozzle by lifting straight up.
- Inspect hose end and clear any obstructions.
- Reinstall the hose and lower plate.

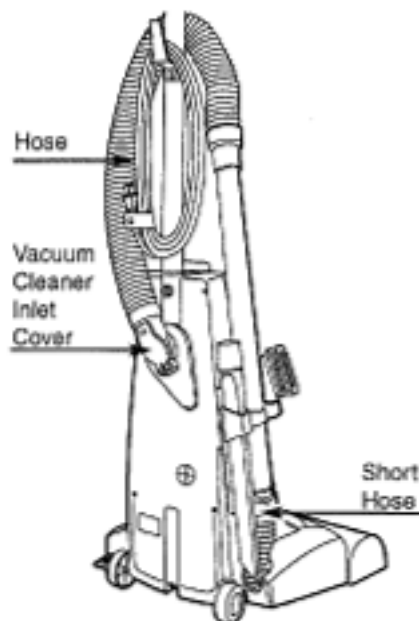

## Cleaning Vacuum Cleaner Exterior

- Unplug cord from the wall outlet.
- Clean exterior of vacuum cleaner using a clean, soft cloth that has been dipped in a solution of mild liquid detergent.
- **DO NOT** drip water on vacuum cleaner, wipe dry after cleaning.

# Troubleshooting Guide

## **WARNING** *Electric Shock or Personal Injury Hazard.*

*Disconnect the electrical supply before servicing or cleaning the vacuum cleaner. Failure to do so could result in electric shock or personal injury from vacuum cleaner suddenly starting.*

Review this chart to find do-it-yourself solutions for minor performance problems. Any service needed, other than those described in these Operating Instructions, should be performed by an authorized service representative.

<b>PROBLEM</b>	<b>POSSIBLE CAUSE</b>	<b>POSSIBLE SOLUTION</b>
<b>Vacuum cleaner will not run.</b>	<ol style="list-style-type: none"><li>1. Unplugged at wall outlet.</li><li>2. ON-OFF switch not turned on.</li><li>3. Tripped circuit breaker/blown fuse at service panel.</li></ol>	<ol style="list-style-type: none"><li>1. Plug in firmly. Push ON-OFF switch to ON.</li><li>2. Push ON-OFF switch to ON.</li><li>3. Reset circuit breaker or replace fuse.</li></ol>
<b>Poor job of dirt pickup.</b>	<ol style="list-style-type: none"><li>1. Full or clogged dust bag.</li><li>2. Broken belt.</li><li>3. Clogged hose or nozzle.</li><li>4. Hose not inserted fully.</li><li>5. Worn agitator.</li><li>6. Hole in hose.</li><li>7. Dust cover improperly installed.</li><li>8. Belt not installed on motor shaft.</li><li>9. Brushes are worn.</li></ol>	<ol style="list-style-type: none"><li>1. Change bag.</li><li>2. Replace belt.</li><li>3. Clean hose or nozzle area.</li><li>4. Insert hose.</li><li>5. Replace agitator.</li><li>6. Replace hose.</li><li>7. Properly install dust cover.</li><li>8. Install belt on motor shaft.</li><li>9. Replace brushes.</li></ol>
<b>Dust escapes the paper bag.</b>	<ol style="list-style-type: none"><li>1. Bag improperly installed.</li><li>2. Bag torn.</li></ol>	<ol style="list-style-type: none"><li>1. Properly install bag.</li><li>2. Replace bag.</li></ol>

# Limited Warranty

The Commercial Warrantor warrants the new vacuum cleaner for 90 days against defects in material and workmanship under normal use and service to the original-end user purchaser. The warranty period is subject to the conditions below:

## Registration of Warranty:

The warranty commences on the date of purchase by the original end user from an authorized distributor, subject to proof of purchase. The warranty registration card must be completed immediately and returned at the time of purchase. If proof of purchase cannot be identified, the warranty starts from the date of sale to the authorized distributor. Parts replaced or repaired under the warranty are warranted for the remainder of the original warranty period.

## Normal Wear Items:

Normal wear items that are not covered by the warranty, include the following items but are not limited to belts; brushes; filters; power cords; etc.

## Warranty is null and void for the following:

- 1) Damage, defects, malfunctions or other failures caused by not using the electric current indicated on the spec plate.
- 2) Damage or defect caused by accident; misuse; neglect; abuse; fire; etc. This includes use of incompatible or corrosive chemicals or overloading of capacity.
- 3) Any design alterations, adjustments and/or repairs performed on the equipment by an organization not authorized or specified by the Commercial Warrantor.
- 4) Failure due to lack of proper maintenance and care (including cleaning).

5) Use of parts not approved by the Commercial Warrantor will void all warranties.

6) If machines are used for a purpose other than that which it was intended.

7) Damage in transit.

## Stated Warranties:

Stated warranties are in lieu of all other warranties, expressed or implied. Any statutory implied warranties, including any warranty of merchantability or fitness for a particular purpose, are expressly limited to the duration of the written warranty. The Commercial Warrantor will not be liable for any other damages, including but not limited to indirect or special consequential damages arising out of or in connection with the furnishing, performance, use or inability to use the vacuum cleaner. This remedy shall be the exclusive remedy of the buyer. The warranty is limited to the warranty.

## Warranty Claim Procedures:

If a difficulty develops during the warranty period, contact the authorized distributor from whom the vacuum cleaner was purchased. The Commercial Warrantor may elect to require the return of vacuum cleaner or components to validate the claim. Any defective part to be returned must be properly packed and shipped freight pre-paid to an Authorized Distributor/Service Center.

**Note:** Because the vacuum cleaner is intended for commercial and/or industrial use the warranty is limited and not applicable to persons purchasing or using this vacuum cleaner for rental, personal, family or household use in which case the 90 day rule applies.